

MAGNETITE ACCUMULATION - Storch fireplace stove

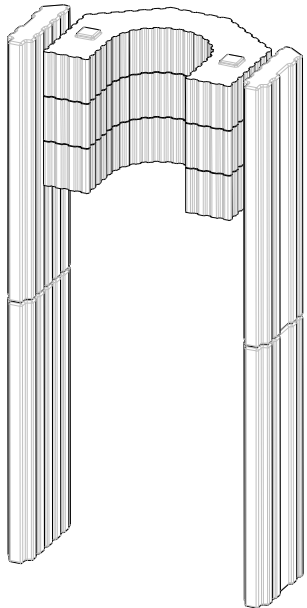

ASKJA SE / EX

75 kg

Product code:

ASK AKKUM

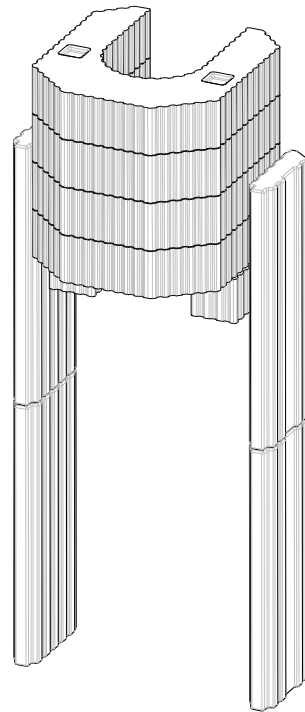

ASKJA H

127 kg

Product code:

ASK H AKKUM

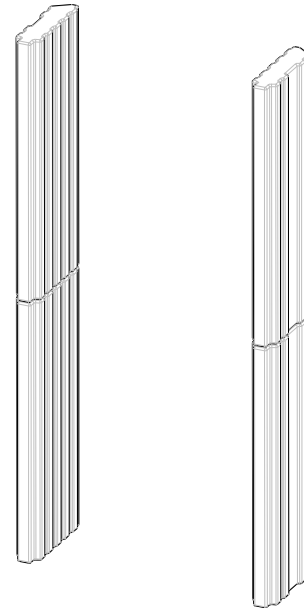

ASKJA BF

40 kg

Product code:

ASK BF AKKUM

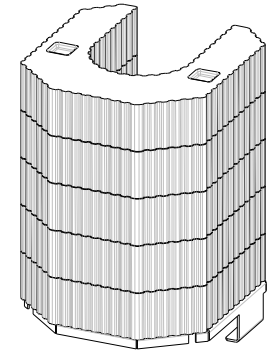

VULSINI H

96 kg

Product code:

VUL H AKKUM

MAGNETITE ACCUMULATION - Storch fireplace stove

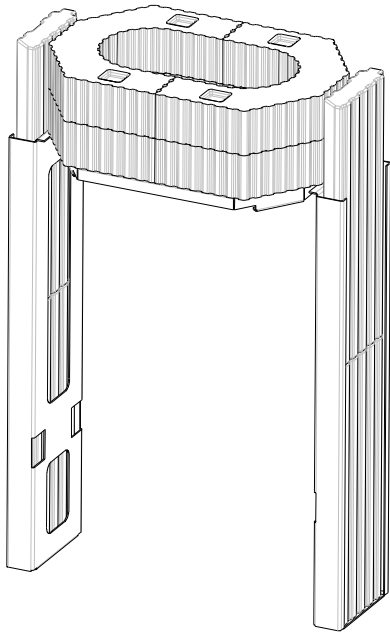

ECUADOR STAHL

93 kg

Product code:

ECU AKKUM 01

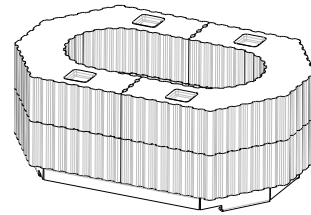

ECUADOR
KERAMIK / STEIN

48 kg

Product code:

ECU AKKUM 02

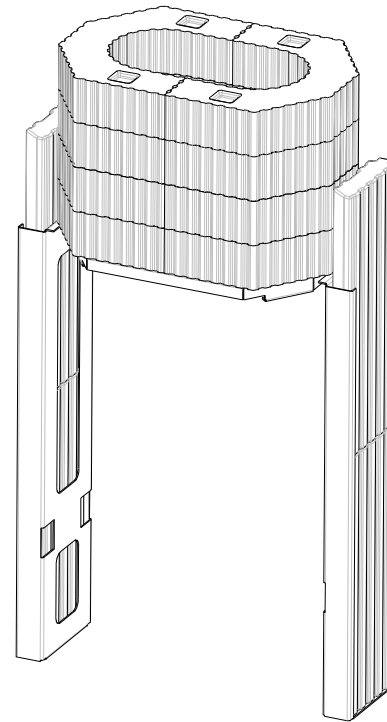

ECUADOR H
STAHL

140 kg

Product code:

ECU H AKKUM 1

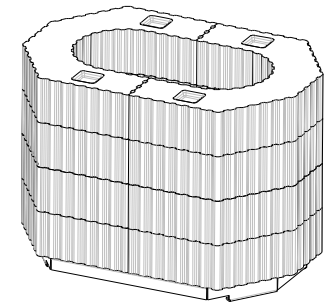

ECUADOR H
KERAMIK / STEIN

94 kg

Product code:

ECU H AKKUM 2